

To our customers,

Old Company Name in Catalogs and Other Documents

On April 1st, 2010, NEC Electronics Corporation merged with Renesas Technology Corporation, and Renesas Electronics Corporation took over all the business of both companies. Therefore, although the old company name remains in this document, it is a valid Renesas Electronics document. We appreciate your understanding.

Renesas Electronics website: <http://www.renesas.com>

April 1st, 2010
Renesas Electronics Corporation

Issued by: Renesas Electronics Corporation (<http://www.renesas.com>)

Send any inquiries to <http://www.renesas.com/inquiry>.

Notice

1. All information included in this document is current as of the date this document is issued. Such information, however, is subject to change without any prior notice. Before purchasing or using any Renesas Electronics products listed herein, please confirm the latest product information with a Renesas Electronics sales office. Also, please pay regular and careful attention to additional and different information to be disclosed by Renesas Electronics such as that disclosed through our website.
2. Renesas Electronics does not assume any liability for infringement of patents, copyrights, or other intellectual property rights of third parties by or arising from the use of Renesas Electronics products or technical information described in this document. No license, express, implied or otherwise, is granted hereby under any patents, copyrights or other intellectual property rights of Renesas Electronics or others.
3. You should not alter, modify, copy, or otherwise misappropriate any Renesas Electronics product, whether in whole or in part.
4. Descriptions of circuits, software and other related information in this document are provided only to illustrate the operation of semiconductor products and application examples. You are fully responsible for the incorporation of these circuits, software, and information in the design of your equipment. Renesas Electronics assumes no responsibility for any losses incurred by you or third parties arising from the use of these circuits, software, or information.
5. When exporting the products or technology described in this document, you should comply with the applicable export control laws and regulations and follow the procedures required by such laws and regulations. You should not use Renesas Electronics products or the technology described in this document for any purpose relating to military applications or use by the military, including but not limited to the development of weapons of mass destruction. Renesas Electronics products and technology may not be used for or incorporated into any products or systems whose manufacture, use, or sale is prohibited under any applicable domestic or foreign laws or regulations.
6. Renesas Electronics has used reasonable care in preparing the information included in this document, but Renesas Electronics does not warrant that such information is error free. Renesas Electronics assumes no liability whatsoever for any damages incurred by you resulting from errors in or omissions from the information included herein.
7. Renesas Electronics products are classified according to the following three quality grades: “Standard”, “High Quality”, and “Specific”. The recommended applications for each Renesas Electronics product depends on the product’s quality grade, as indicated below. You must check the quality grade of each Renesas Electronics product before using it in a particular application. You may not use any Renesas Electronics product for any application categorized as “Specific” without the prior written consent of Renesas Electronics. Further, you may not use any Renesas Electronics product for any application for which it is not intended without the prior written consent of Renesas Electronics. Renesas Electronics shall not be in any way liable for any damages or losses incurred by you or third parties arising from the use of any Renesas Electronics product for an application categorized as “Specific” or for which the product is not intended where you have failed to obtain the prior written consent of Renesas Electronics. The quality grade of each Renesas Electronics product is “Standard” unless otherwise expressly specified in a Renesas Electronics data sheets or data books, etc.
 - “Standard”: Computers; office equipment; communications equipment; test and measurement equipment; audio and visual equipment; home electronic appliances; machine tools; personal electronic equipment; and industrial robots.
 - “High Quality”: Transportation equipment (automobiles, trains, ships, etc.); traffic control systems; anti-disaster systems; anti-crime systems; safety equipment; and medical equipment not specifically designed for life support.
 - “Specific”: Aircraft; aerospace equipment; submersible repeaters; nuclear reactor control systems; medical equipment or systems for life support (e.g. artificial life support devices or systems), surgical implantations, or healthcare intervention (e.g. excision, etc.), and any other applications or purposes that pose a direct threat to human life.
8. You should use the Renesas Electronics products described in this document within the range specified by Renesas Electronics, especially with respect to the maximum rating, operating supply voltage range, movement power voltage range, heat radiation characteristics, installation and other product characteristics. Renesas Electronics shall have no liability for malfunctions or damages arising out of the use of Renesas Electronics products beyond such specified ranges.
9. Although Renesas Electronics endeavors to improve the quality and reliability of its products, semiconductor products have specific characteristics such as the occurrence of failure at a certain rate and malfunctions under certain use conditions. Further, Renesas Electronics products are not subject to radiation resistance design. Please be sure to implement safety measures to guard them against the possibility of physical injury, and injury or damage caused by fire in the event of the failure of a Renesas Electronics product, such as safety design for hardware and software including but not limited to redundancy, fire control and malfunction prevention, appropriate treatment for aging degradation or any other appropriate measures. Because the evaluation of microcomputer software alone is very difficult, please evaluate the safety of the final products or system manufactured by you.
10. Please contact a Renesas Electronics sales office for details as to environmental matters such as the environmental compatibility of each Renesas Electronics product. Please use Renesas Electronics products in compliance with all applicable laws and regulations that regulate the inclusion or use of controlled substances, including without limitation, the EU RoHS Directive. Renesas Electronics assumes no liability for damages or losses occurring as a result of your noncompliance with applicable laws and regulations.
11. This document may not be reproduced or duplicated, in any form, in whole or in part, without prior written consent of Renesas Electronics.
12. Please contact a Renesas Electronics sales office if you have any questions regarding the information contained in this document or Renesas Electronics products, or if you have any other inquiries.

(Note 1) “Renesas Electronics” as used in this document means Renesas Electronics Corporation and also includes its majority-owned subsidiaries.

(Note 2) “Renesas Electronics product(s)” means any product developed or manufactured by or for Renesas Electronics.

HAF1004(L), HAF1004(S)

Silicon P Channel MOS FET Series Power Switching

REJ03G0028-0500Z
(Previous ADE-208-629B (Z))
Rev.5.00
2003.04.29

Description

This FET has the over temperature shut-down capability sensing to the junction temperature. This FET has the built-in over temperature shut-down circuit in the gate area. And this circuit operation to shut-down the gate voltage in case of high junction temperature like applying over power consumption, over current etc..

Features

- Logic level operation to (-4 to -6 V Gate drive)
- High endurance capability against to the shut-down circuit
- Built-in the over temperature shut-down circuit
- Latch type shut down operation (need 0 voltage recovery)

Outline

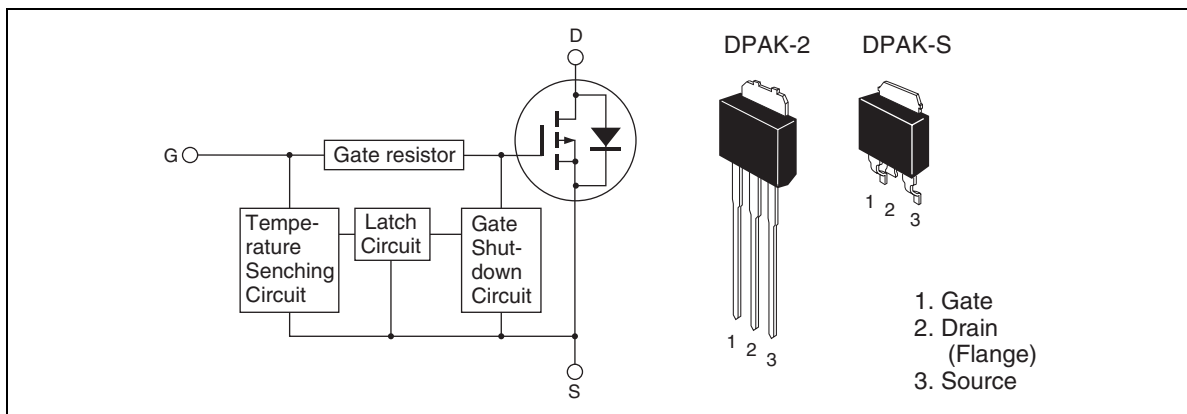

HAF1004(L), HAF1004(S)

Absolute Maximum Ratings

(Ta = 25°C)

Item	Symbol	Ratings	Unit
Drain to source voltage	V _{DSS}	-60	V
Gate to source voltage	V _{GSS}	-16	V
Gate to source voltage	V _{GSS}	2.5	V
Drain current	I _D	-5	A
Drain peak current	I _{D (pulse)} ^{Note1}	-10	A
Body-drain diode reverse drain current	I _{DR}	-5	A
Channel dissipation	P _{ch} ^{Note2}	20	W
Channel temperature	T _{ch}	150	°C
Storage temperature	T _{stg}	-55 to +150	°C

Notes: 1. PW ≤ 0μs, duty cycle ≤ 1%
2. Value at Ta = 25°C

Typical Operation Characteristics

Item	Symbol	Min	Typ	Max	Unit	Test Conditions
Input voltage	V _{IH}	-3.5	—	—	V	
	V _{IL}	—	—	-1.2	V	
Input current (Gate non shut down)	I _{IH1}	—	—	-100	μA	V _i = -8 V, V _{DS} = 0
	I _{IH2}	—	—	-50	μA	V _i = -3.5 V, V _{DS} = 0
	I _{IL}	—	—	-1	μA	V _i = -1.2 V, V _{DS} = 0
Input current (Gate shut down)	I _{IH(sd)1}	—	-0.8	—	mA	V _i = -8 V, V _{DS} = 0
	I _{IH(sd)2}	—	-0.35	—	mA	V _i = -3.5 V, V _{DS} = 0
Shut down temperature	T _{sd}	—	175	—	°C	Channel temperature
Gate operation voltage	V _{op}	-3.5	—	-12	V	

HAF1004(L), HAF1004(S)

Electrical Characteristics

(Ta = 25°C)

Item	Symbol	Min	Typ	Max	Unit	Test Conditions
Drain current	I _{D1}	4	—	—	A	V _{GS} = -3.5 V, V _{DS} = -2 V
Drain current	I _{D2}	—	—	-10	mA	V _{GS} = -1.2 V, V _{DS} = -2 V
Drain to source breakdown voltage	V _{(BR)DSS}	-60	—	—	V	I _D = -10 mA, V _{GS} = 0
Gate to source breakdown voltage	V _{(BR)GSS}	-16	—	—	V	I _G = -800 μA, V _{DS} = 0
Gate to source breakdown voltage	V _{(BR)GSS}	2.5	—	—	V	I _G = 100 μA, V _{DS} = 0
Gate to source leak current	I _{GSS1}	—	—	-100	μA	V _{GS} = -8 V, V _{DS} = 0
	I _{GSS2}	—	—	-50	μA	V _{GS} = -3.5 V, V _{DS} = 0
	I _{GSS3}	—	—	-1	μA	V _{GS} = -1.2 V, V _{DS} = 0
	I _{GSS4}	—	—	100	μA	V _{GS} = 2.4 V, V _{DS} = 0
Input current (shut down)	I _{GS(OP)1}	—	-0.8	—	mA	V _{GS} = -8 V, V _{DS} = 0
	I _{GS(OP)2}	—	-0.35	—	mA	V _{GS} = -3.5 V, V _{DS} = 0
Zero gate voltage drain current	I _{DSS}	—	—	-10	μA	V _{DS} = -60 V, V _{GS} = 0
Gate to source cut off voltage	V _{GS(off)}	-1.1	—	-2.25	V	V _{DS} = -10 V, I _D = -1 mA
Forward transfer admittance	y _{fs}	2	4	—	S	I _D = -2.5 A, V _{DS} = -10 V ^{Note3}
Static drain to source on state resistance	R _{DS(on)}	—	140	200	mΩ	I _D = -2.5 A, V _{GS} = -10 V ^{Note3}
Static drain to source on state resistance	R _{DS(on)}	—	200	340	mΩ	I _D = -2.5 A, V _{GS} = -4 V ^{Note3}
Output capacitance	C _{oss}	—	326	—	pF	V _{DS} = -10 V, V _{GS} = 0, f = 1 MHz
Turn-on delay time	t _{d(on)}	—	2	—	μs	V _{GS} = -5 V, I _D = -2.5 A, R _L = 12 Ω
Rise time	t _r	—	7.6	—	μs	
Turn off delay time	t _{d(off)}	—	3.2	—	μs	
Fall time	t _f	—	3.2	—	μs	
Body-drain diode forward voltage	V _{DF}	—	-0.9	—	V	I _F = -5A, V _{GS} = 0
Body-drain diode reverse recovery time	t _{rr}	—	77	—	ns	I _F = -5 A, V _{GS} = 0 diF/dt = 50 A/μs
Over load shut down operation time ^{note4}	t _{os1}	—	8.4	—	ms	V _{GS} = -5 V, V _{DD} = -16 V
	t _{os2}	—	2.4	—	ms	V _{GS} = -5 V, V _{DD} = -24 V

Notes: 3. Pulse test

4. Including the junction temperature rise of the loded condition

Main Characteristics

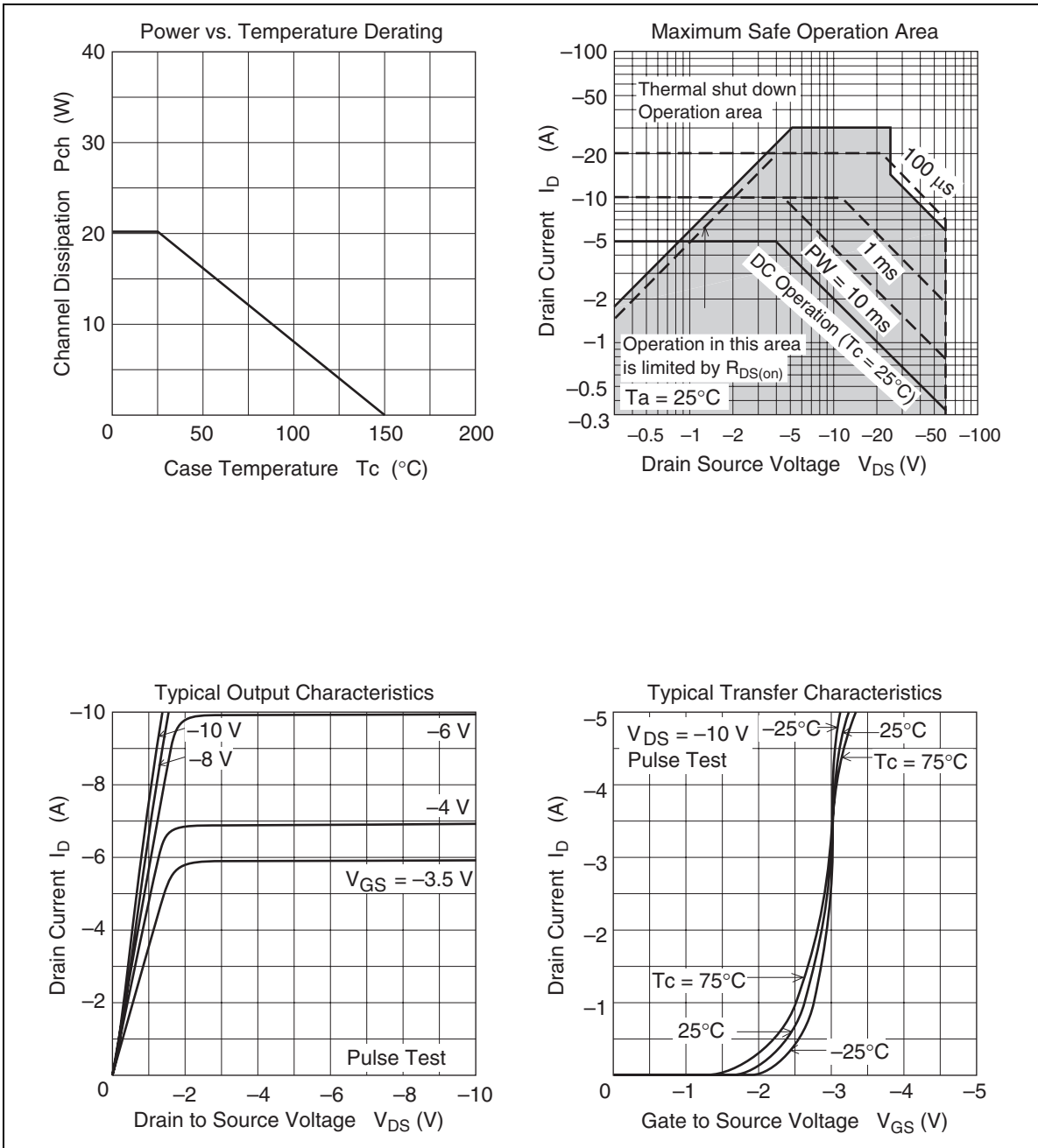

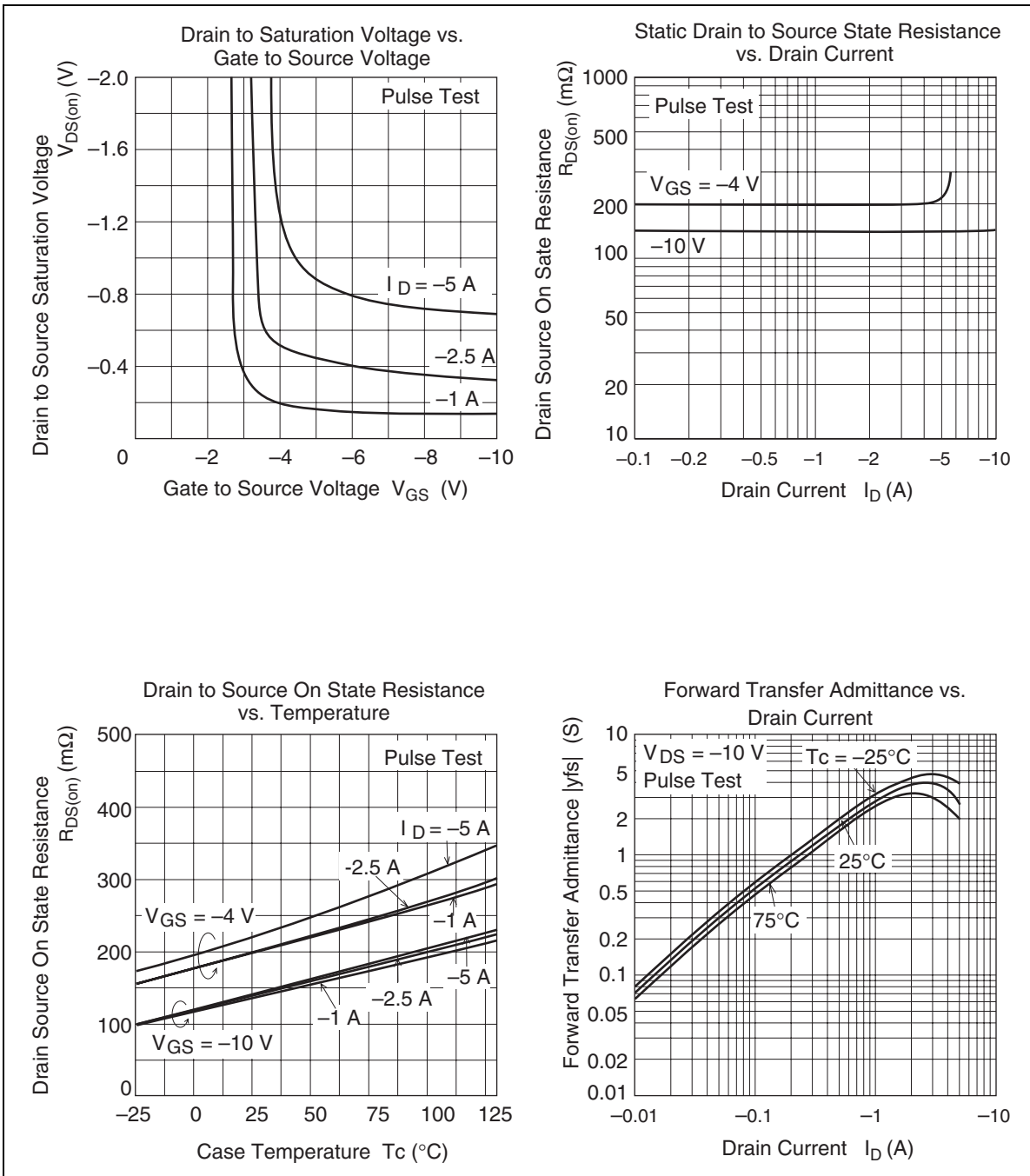

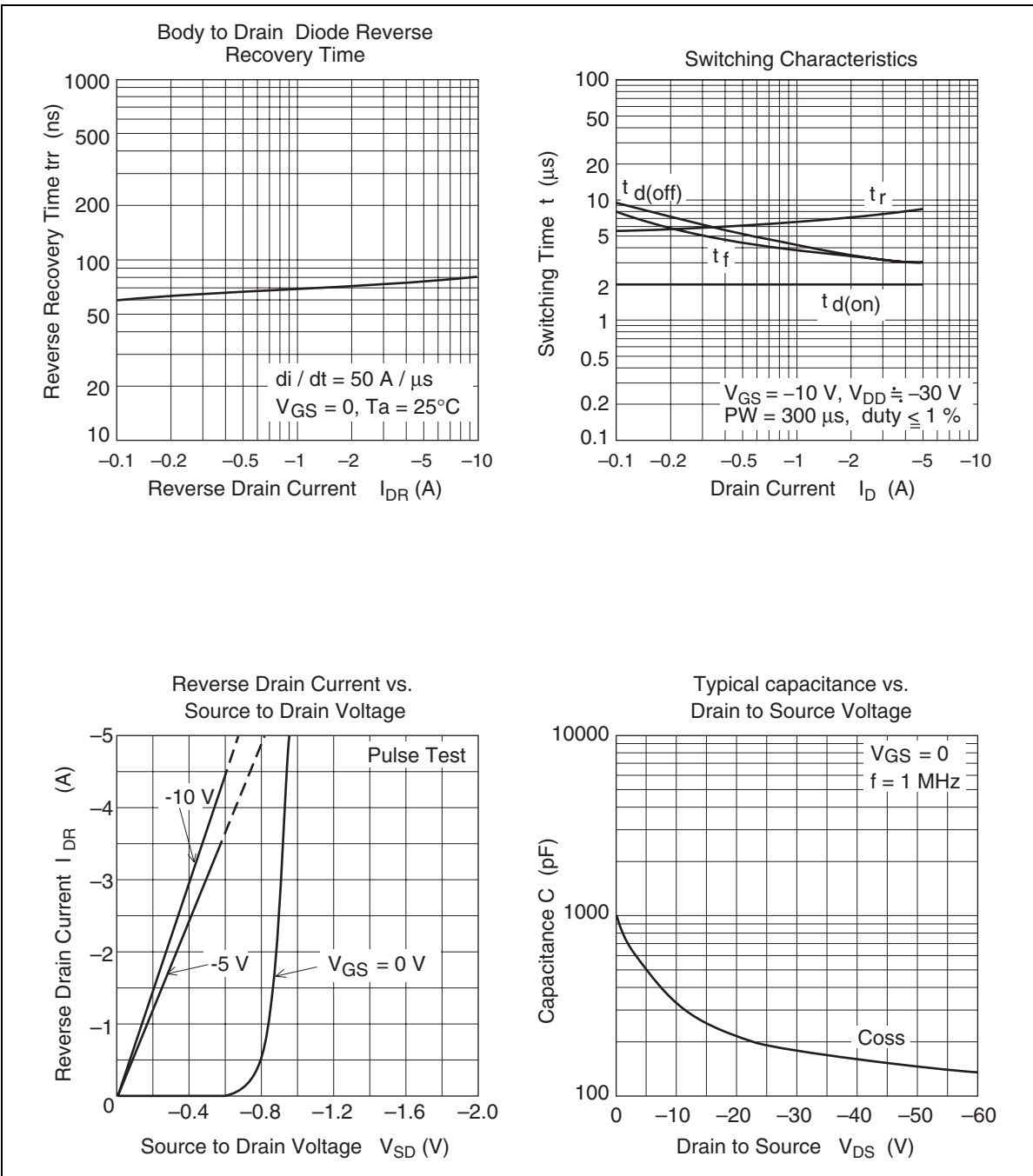

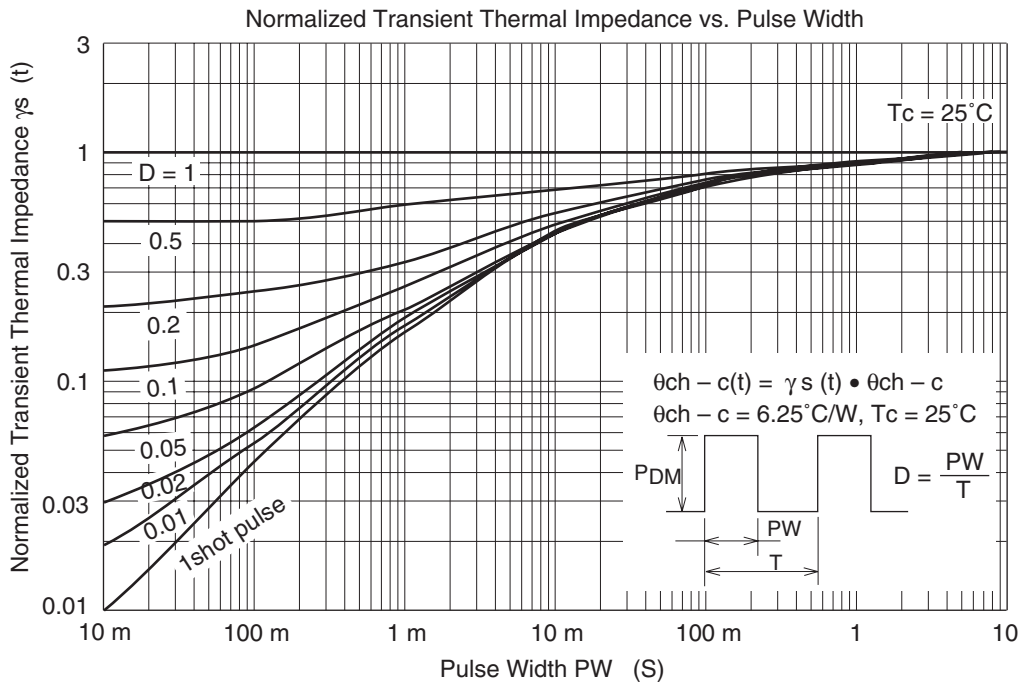
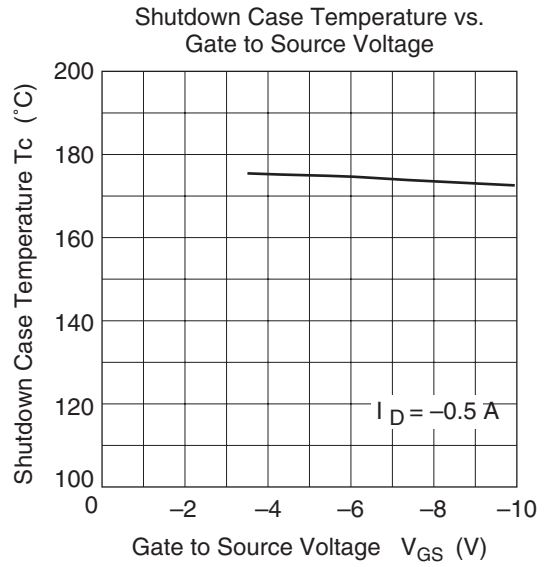
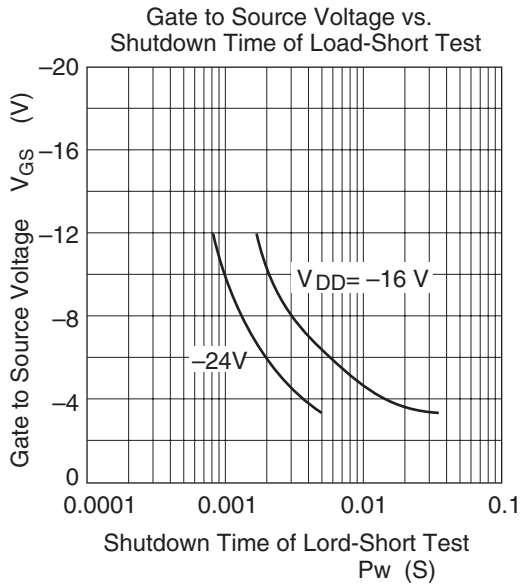

Package Dimensions

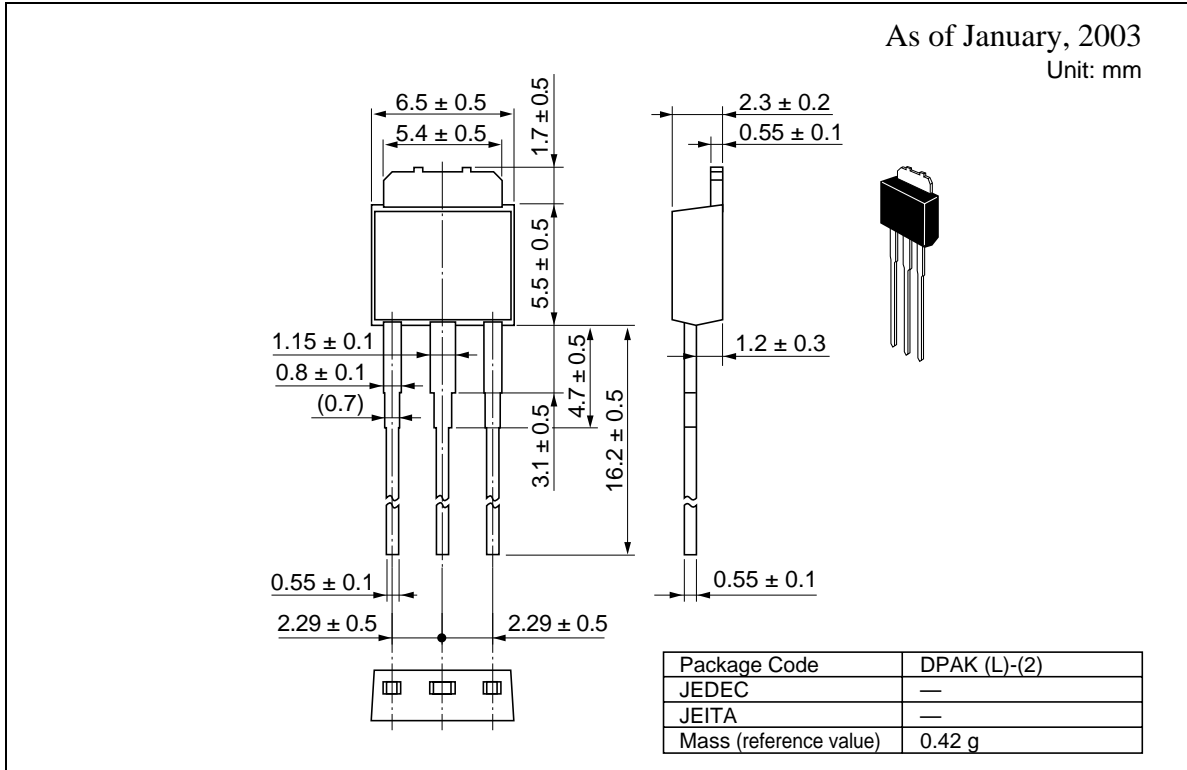

Renesas Technology Corp. Sales Strategic Planning Div. Nippon Bldg., 2-6-2, Ohte-machi, Chiyoda-ku, Tokyo 100-0004, Japan

Keep safety first in your circuit designs!

1. Renesas Technology Corporation puts the maximum effort into making semiconductor products better and more reliable, but there is always the possibility that trouble may occur with them. Trouble with semiconductors may lead to personal injury, fire or property damage.
Remember to give due consideration to safety when making your circuit designs, with appropriate measures such as (i) placement of substitutive, auxiliary circuits, (ii) use of nonflammable material or (iii) prevention against any malfunction or mishap.

Notes regarding these materials

1. These materials are intended as a reference to assist our customers in the selection of the Renesas Technology Corporation product best suited to the customer's application; they do not convey any license under any intellectual property rights, or any other rights, belonging to Renesas Technology Corporation or a third party.
 2. Renesas Technology Corporation assumes no responsibility for any damage, or infringement of any third-party's rights, originating in the use of any product data, diagrams, charts, programs, algorithms, or circuit application examples contained in these materials.
 3. All information contained in these materials, including product data, diagrams, charts, programs and algorithms represents information on products at the time of publication of these materials, and are subject to change by Renesas Technology Corporation without notice due to product improvements or other reasons. It is therefore recommended that customers contact Renesas Technology Corporation or an authorized Renesas Technology Corporation product distributor for the latest product information before purchasing a product listed herein.
The information described here may contain technical inaccuracies or typographical errors.
Renesas Technology Corporation assumes no responsibility for any damage, liability, or other loss rising from these inaccuracies or errors.
Please also pay attention to information published by Renesas Technology Corporation by various means, including the Renesas Technology Corporation Semiconductor home page (<http://www.renesas.com>).
 4. When using any or all of the information contained in these materials, including product data, diagrams, charts, programs, and algorithms, please be sure to evaluate all information as a total system before making a final decision on the applicability of the information and products. Renesas Technology Corporation assumes no responsibility for any damage, liability or other loss resulting from the information contained herein.
 5. Renesas Technology Corporation semiconductors are not designed or manufactured for use in a device or system that is used under circumstances in which human life is potentially at stake. Please contact Renesas Technology Corporation or an authorized Renesas Technology Corporation product distributor when considering the use of a product contained herein for any specific purposes, such as apparatus or systems for transportation, vehicular, medical, aerospace, nuclear, or undersea repeater use.
 6. The prior written approval of Renesas Technology Corporation is necessary to reprint or reproduce in whole or in part these materials.
 7. If these products or technologies are subject to the Japanese export control restrictions, they must be exported under a license from the Japanese government and cannot be imported into a country other than the approved destination.
Any diversion or reexport contrary to the export control laws and regulations of Japan and/or the country of destination is prohibited.
 8. Please contact Renesas Technology Corporation for further details on these materials or the products contained therein.
-



<http://www.renesas.com>



Copyright © 2003. Renesas Technology Corporation, All rights reserved. Printed in Japan.
Colophon 0.0